

## Description

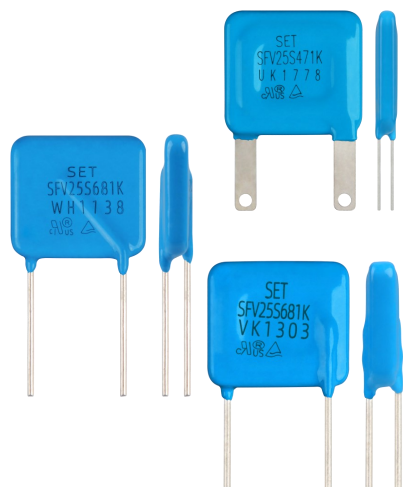

Metal Oxide Varistor (MOV) is a nonlinear resistance component with zinc oxide (ZnO) as its main constituent. The resistance of an MOV is sensitive to changes in the applied voltage. Below the threshold voltage, the MOV exhibits high resistance, allowing only a negligibly small leakage current to flow. Once the threshold voltage is exceeded, the resistance of the MOV drops sharply, enabling the conduction of a large current. This characteristic makes the MOV suitable for detecting and suppressing surge voltage and overvoltage, thereby protecting the circuit from damage caused by excessive voltage.

The Metal Oxide Varistor (MOV) finds wide application in various fields such as photovoltaics, communication, lightning protection, power supply, and power strips. It serves to suppress transient overvoltage and absorb surge energy within the circuit.

SETsafe | SETfuse offers Metal Oxide Varistors (MOV) with maximum peak current ratings ranging from 0.75 kA to 70 kA, and maximum continuous voltage ratings from 14VAC to 750 VAC. Safety certification includes UL, cUL, TUV, and CQC, and complies with RoHS and REACH requirements.

## Product Structure

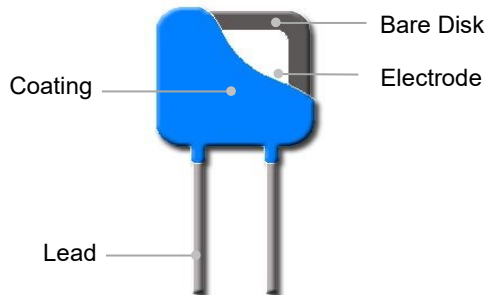

## Lead Types

Lead Types	Codes
Straight Lead	A
Straight Strap Lead	E
All Lead Wire A	L

## Agency Information

Agency	Standards	No.
	UL 1449 4 <sup>th</sup> Edition	E322662
	CSA C22.2 NO.269.5-17	E322662
	EN IEC 61051-1:2018 EN IEC 61051-2:2021 IEC 61051-2-2:1991 Annex G.8.1 of IEC 62368-1: 2023	J 50401611

## Applications

- Power Supplies
- Home Electrical Appliances
- Industrial Devices
- Surge Protectors
- Telecom Devices

### Marking

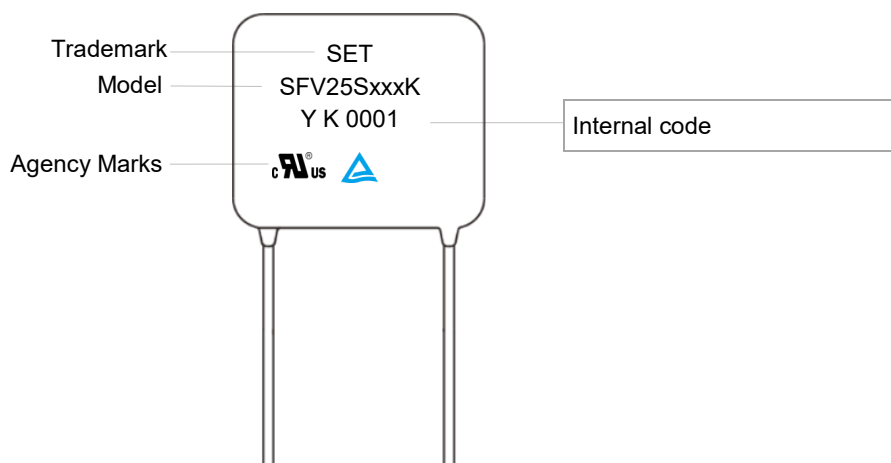

### Temp. Derating Curve

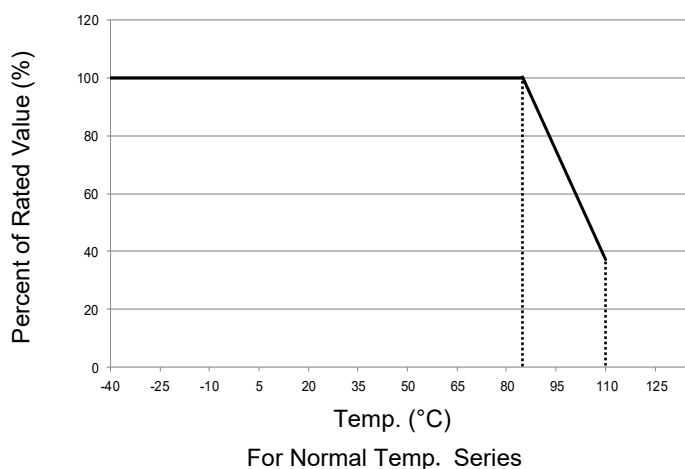

**Note:**  
When ambient Temp. exceeds 85 °C, the peak surge current and energy rating should be reduced as shown in left curve.

### General Technical Data

Item	Value	Unit
Operating Temperature	-40 to +85	°C
Storage Temperature	-40 to +125	°C
Voltage Proof	≥2500	V <sub>ac</sub>
Insulation Resistance	≥100	MΩ

**Dimensions (mm)**



Straight Strap Lead

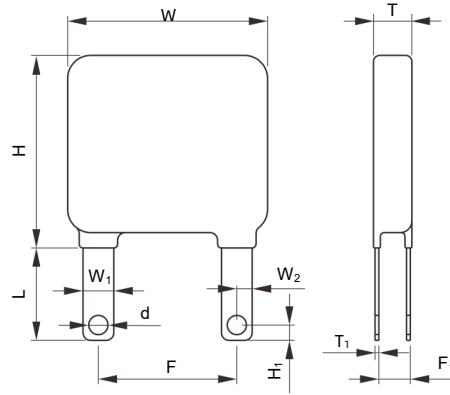

Model	L	W (Max.)	W <sub>1</sub>	W <sub>2</sub>	H (Max.)	H <sub>1</sub>	T (Max.)	T <sub>1</sub>	d	F	F <sub>1</sub>
SFV25S220	12.0±3.0	28	4.00±0.05	2.00±0.05	30	2.00±0.05	4.2	0.50±0.05	2.50±0.05	18.0±1.0	0.8 ~ 2.2
SFV25S270	12.0±3.0	28	4.00±0.05	2.00±0.05	30	2.00±0.05	4.5	0.50±0.05	2.50±0.05	18.0±1.0	0.9 ~ 2.4
SFV25S330	12.0±3.0	28	4.00±0.05	2.00±0.05	30	2.00±0.05	4.8	0.50±0.05	2.50±0.05	18.0±1.0	1.0 ~ 2.6
SFV25S390	12.0±3.0	28	4.00±0.05	2.00±0.05	30	2.00±0.05	5.1	0.50±0.05	2.50±0.05	18.0±1.0	1.1 ~ 2.8
SFV25S470	12.0±3.0	28	4.00±0.05	2.00±0.05	30	2.00±0.05	4.3	0.50±0.05	2.50±0.05	18.0±1.0	0.9 ~ 2.4
SFV25S560	12.0±3.0	28	4.00±0.05	2.00±0.05	30	2.00±0.05	4.5	0.50±0.05	2.50±0.05	18.0±1.0	1.0 ~ 2.6
SFV25S680	12.0±3.0	28	4.00±0.05	2.00±0.05	30	2.00±0.05	4.8	0.50±0.05	2.50±0.05	18.0±1.0	1.2 ~ 2.9
SFV25S820	12.0±3.0	28	4.00±0.05	2.00±0.05	30	2.00±0.05	4.1	0.50±0.05	2.50±0.05	18.0±1.0	0.9 ~ 2.3
SFV25S101	12.0±3.0	28	4.00±0.05	2.00±0.05	30	2.00±0.05	4.3	0.50±0.05	2.50±0.05	18.0±1.0	1.0 ~ 2.5
SFV25S121	12.0±3.0	28	4.00±0.05	2.00±0.05	30	2.00±0.05	4.5	0.50±0.05	2.50±0.05	18.0±1.0	1.1 ~ 2.7
SFV25S151	12.0±3.0	28	4.00±0.05	2.00±0.05	30	2.00±0.05	4.8	0.50±0.05	2.50±0.05	18.0±1.0	1.4 ~ 3.0
SFV25S181	12.0±3.0	28	4.00±0.05	2.00±0.05	30	2.00±0.05	4.3	0.50±0.05	2.50±0.05	18.0±1.0	1.1 ~ 2.6
SFV25S201	12.0±3.0	28	4.00±0.05	2.00±0.05	30	2.00±0.05	4.4	0.50±0.05	2.50±0.05	18.0±1.0	1.2 ~ 2.7
SFV25S221	12.0±3.0	28	4.00±0.05	2.00±0.05	30	2.00±0.05	4.5	0.50±0.05	2.50±0.05	18.0±1.0	1.3 ~ 2.8
SFV25S241	12.0±3.0	28	4.00±0.05	2.00±0.05	30	2.00±0.05	4.6	0.50±0.05	2.50±0.05	18.0±1.0	1.4 ~ 2.9
SFV25S271	12.0±3.0	28	4.00±0.05	2.00±0.05	30	2.00±0.05	4.8	0.50±0.05	2.50±0.05	18.0±1.0	1.5 ~ 3.1
SFV25S301	12.0±3.0	28	4.00±0.05	2.00±0.05	30	2.00±0.05	5.0	0.50±0.05	2.50±0.05	18.0±1.0	1.6 ~ 3.3
SFV25S331	12.0±3.0	28	4.00±0.05	2.00±0.05	30	2.00±0.05	5.2	0.50±0.05	2.50±0.05	18.0±1.0	1.7 ~ 3.4
SFV25S361	12.0±3.0	28	4.00±0.05	2.00±0.05	30	2.00±0.05	5.4	0.50±0.05	2.50±0.05	18.0±1.0	1.8 ~ 3.6
SFV25S391	12.0±3.0	28	4.00±0.05	2.00±0.05	30	2.00±0.05	5.6	0.50±0.05	2.50±0.05	18.0±1.0	1.9 ~ 3.8
SFV25S431	12.0±3.0	28	4.00±0.05	2.00±0.05	30	2.00±0.05	5.8	0.50±0.05	2.50±0.05	18.0±1.0	2.0 ~ 4.0
SFV25S471	12.0±3.0	28	4.00±0.05	2.00±0.05	30	2.00±0.05	6.1	0.50±0.05	2.50±0.05	18.0±1.0	2.3 ~ 4.3
SFV25S511	12.0±3.0	28	4.00±0.05	2.00±0.05	30	2.00±0.05	6.3	0.50±0.05	2.50±0.05	18.0±1.0	2.5 ~ 4.5
SFV25S561	12.0±3.0	28	4.00±0.05	2.00±0.05	30	2.00±0.05	6.6	0.50±0.05	2.50±0.05	18.0±1.0	2.8 ~ 4.8
SFV25S621	12.0±3.0	28	4.00±0.05	2.00±0.05	30	2.00±0.05	7.0	0.50±0.05	2.50±0.05	18.0±1.0	3.1 ~ 5.1
SFV25S681	12.0±3.0	28	4.00±0.05	2.00±0.05	30	2.00±0.05	7.4	0.50±0.05	2.50±0.05	18.0±1.0	3.5 ~ 5.5
SFV25S751	12.0±3.0	28	4.00±0.05	2.00±0.05	30	2.00±0.05	7.8	0.50±0.05	2.50±0.05	18.0±1.0	3.9 ~ 5.9
SFV25S821	12.0±3.0	28	4.00±0.05	2.00±0.05	30	2.00±0.05	8.3	0.50±0.05	2.50±0.05	18.0±1.0	4.3 ~ 6.3
SFV25S911	12.0±3.0	28	4.00±0.05	2.00±0.05	30	2.00±0.05	8.8	0.50±0.05	2.50±0.05	18.0±1.0	4.9 ~ 6.9
SFV25S102	12.0±3.0	28	4.00±0.05	2.00±0.05	30	2.00±0.05	9.4	0.50±0.05	2.50±0.05	18.0±1.0	5.4 ~ 7.4
SFV25S112	12.0±3.0	28	4.00±0.05	2.00±0.05	30	2.00±0.05	10.0	0.50±0.05	2.50±0.05	18.0±1.0	6.0 ~ 8.0
SFV25S122	12.0±3.0	28	4.00±0.05	2.00±0.05	30	2.00±0.05	10.6	0.50±0.05	2.50±0.05	18.0±1.0	6.6 ~ 8.6

**Dimensions (mm)**

Model	L (Min.)	W (Max.)	H (Max.)	T (Max.)	d	F	F <sub>1</sub>	A (Max.)
SFV25S220K	16.0±3	28	30	6.6	1.20±0.05	18.0±1.0	2.0 ~ 3.9	27.5
SFV25S270K	16.0±3	28	30	6.9	1.20±0.05	18.0±1.0	2.1 ~ 4.1	27.5
SFV25S330K	16.0±3	28	30	7.2	1.20±0.05	18.0±1.0	2.3 ~ 4.3	27.5
SFV25S390K	16.0±3	28	30	7.5	1.20±0.05	18.0±1.0	2.5 ~ 4.5	27.5
SFV25S470K	16.0±3	28	30	6.7	1.20±0.05	18.0±1.0	2.1 ~ 4.1	27.5
SFV25S560K	16.0±3	28	30	6.9	1.20±0.05	18.0±1.0	2.3 ~ 4.3	27.5
SFV25S680K	16.0±3	28	30	7.2	1.20±0.05	18.0±1.0	2.6 ~ 4.6	27.5
SFV25S820K	16.0±3	28	30	6.5	1.20±0.05	18.0±1.0	2.0 ~ 4.0	27.5
SFV25S101K	16.0±3	28	30	6.7	1.20±0.05	18.0±1.0	2.2 ~ 4.2	27.5
SFV25S121K	16.0±3	28	30	6.9	1.20±0.05	18.0±1.0	2.4 ~ 4.4	27.5
SFV25S151K	16.0±3	28	30	7.2	1.20±0.05	18.0±1.0	2.7 ~ 4.7	27.5
SFV25S181K	16.0±3	28	30	6.7	1.20±0.05	18.0±1.0	2.3 ~ 4.3	27.5
SFV25S201K	16.0±3	28	30	6.8	1.20±0.05	18.0±1.0	2.4 ~ 4.4	27.5
SFV25S221K	16.0±3	28	30	6.9	1.20±0.05	18.0±1.0	2.5 ~ 4.5	27.5
SFV25S241K	16.0±3	28	30	7.0	1.20±0.05	18.0±1.0	2.6 ~ 4.6	27.5
SFV25S271K	16.0±3	28	30	7.2	1.20±0.05	18.0±1.0	2.8 ~ 4.8	27.5
SFV25S301K	16.0±3	28	30	7.4	1.20±0.05	18.0±1.0	3.0 ~ 5.0	27.5
SFV25S331K	16.0±3	28	30	7.6	1.20±0.05	18.0±1.0	3.1 ~ 5.1	27.5
SFV25S361K	16.0±3	28	30	7.8	1.20±0.05	18.0±1.0	3.3 ~ 5.3	27.5
SFV25S391K	16.0±3	28	30	8.0	1.20±0.05	18.0±1.0	3.5 ~ 5.5	27.5
SFV25S431K	16.0±3	28	30	8.2	1.20±0.05	18.0±1.0	3.7 ~ 5.7	27.5
SFV25S471K	16.0±3	28	30	8.5	1.20±0.05	18.0±1.0	4.0 ~ 6.0	27.5
SFV25S511K	16.0±3	28	30	8.7	1.20±0.05	18.0±1.0	4.2 ~ 6.2	27.5
SFV25S561K	16.0±3	28	30	9.0	1.20±0.05	18.0±1.0	4.5 ~ 6.5	27.5
SFV25S621K	16.0±3	28	30	9.4	1.20±0.05	18.0±1.0	4.8 ~ 6.8	27.5
SFV25S681K	16.0±3	28	30	9.8	1.20±0.05	18.0±1.0	5.2 ~ 7.2	27.5
SFV25S751K	16.0±3	28	30	10.2	1.20±0.05	18.0±1.0	5.6 ~ 7.6	27.5
SFV25S821K	16.0±3	28	30	10.7	1.20±0.05	18.0±1.0	6.0 ~ 8.0	27.5
SFV25S911K	16.0±3	28	30	11.2	1.20±0.05	18.0±1.0	6.6 ~ 8.6	27.5
SFV25S102K	16.0±3	28	30	11.8	1.20±0.05	18.0±1.0	7.1 ~ 9.1	27.5
SFV25S112K	16.0±3	28	30	12.4	1.20±0.05	18.0±1.0	7.7 ~ 9.7	27.5
SFV25S122K	16.0±3	28	30	13.0	1.20±0.05	18.0±1.0	8.3 ~ 10.3	27.5

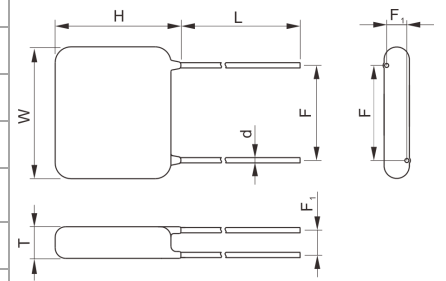

Straight Lead

Note:  
The above data is for reference only.

**Dimensions (mm)**

Model	L (Min.)	W (Max.)	H (Max.)	T (Max.)	d	F	F <sub>1</sub>	A (Max.)
SFV25S220K	20	28	30	6.6	1.20±0.05	18.0±0.	2.0 ~ 3.9	27.5
SFV25S270K	20	28	30	6.9	1.20±0.05	18.0±0.	2.1 ~ 4.1	27.5
SFV25S330K	20	28	30	7.2	1.20±0.05	18.0±0.	2.3 ~ 4.3	27.5
SFV25S390K	20	28	30	7.5	1.20±0.05	18.0±0.	2.5 ~ 4.5	27.5
SFV25S470K	20	28	30	6.7	1.20±0.05	18.0±0.	2.1 ~ 4.1	27.5
SFV25S560K	20	28	30	6.9	1.20±0.05	18.0±0.	2.3 ~ 4.3	27.5
SFV25S680K	20	28	30	7.2	1.20±0.05	18.0±0.	2.6 ~ 4.6	27.5
SFV25S820K	20	28	30	6.5	1.20±0.05	18.0±0.	2.0 ~ 4.0	27.5
SFV25S101K	20	28	30	6.7	1.20±0.05	18.0±0.	2.2 ~ 4.2	27.5
SFV25S121K	20	28	30	6.9	1.20±0.05	18.0±0.	2.4 ~ 4.4	27.5
SFV25S151K	20	28	30	7.2	1.20±0.05	18.0±0.	2.7 ~ 4.7	27.5
SFV25S181K	20	28	30	5.3	1.20±0.05	18.0±0.	1.4 ~ 3.2	27.5
SFV25S201K	20	28	30	5.4	1.20±0.05	18.0±0.	1.5 ~ 3.2	27.5
SFV25S221K	20	28	30	5.5	1.20±0.05	18.0±0.	1.6 ~ 3.4	27.5
SFV25S241K	20	28	30	5.7	1.20±0.05	18.0±0.	1.7 ~ 3.5	27.5
SFV25S271K	20	28	30	5.6	1.20±0.05	18.0±0.	1.8 ~ 3.6	27.5
SFV25S301K	20	28	30	5.7	1.20±0.05	18.0±0.	1.9 ~ 3.8	27.5
SFV25S331K	20	28	30	5.9	1.20±0.05	18.0±0.	2.0 ~ 4.0	27.5
SFV25S361K	20	28	30	6.0	1.20±0.05	18.0±0.	2.2 ~ 4.2	27.5
SFV25S391K	20	28	30	6.2	1.20±0.05	18.0±0.	2.3 ~ 4.3	27.5
SFV25S431K	20	28	30	6.4	1.20±0.05	18.0±0.	2.6 ~ 4.6	27.5
SFV25S471K	20	28	30	6.7	1.20±0.05	18.0±0.	2.8 ~ 4.8	27.5
SFV25S511K	20	28	30	6.8	1.20±0.05	18.0±0.	3.1 ~ 5.1	27.5
SFV25S561K	20	28	30	7.0	1.20±0.05	18.0±0.	3.3 ~ 5.3	27.5
SFV25S621K	20	28	30	7.3	1.20±0.05	18.0±0.	3.7 ~ 5.7	27.5
SFV25S681K	20	28	30	7.6	1.20±0.05	18.0±0.	4.1 ~ 6.1	27.5
SFV25S751K	20	28	30	8.0	1.20±0.05	18.0±0.	4.5 ~ 6.5	27.5
SFV25S821K	20	28	30	8.3	1.20±0.05	18.0±0.	4.9 ~ 6.9	27.5
SFV25S911K	20	28	30	8.8	1.20±0.05	18.0±0.	5.4 ~ 7.4	27.5
SFV25S102K	20	28	30	9.2	1.20±0.05	18.0±0.	5.9 ~ 7.9	27.5
SFV25S112K	20	28	30	9.7	1.20±0.05	18.0±0.	6.5 ~ 8.5	27.5
SFV25S122K	20	28	30	10.2	1.20±0.05	18.0±0.	7.1 ~ 9.1	27.5

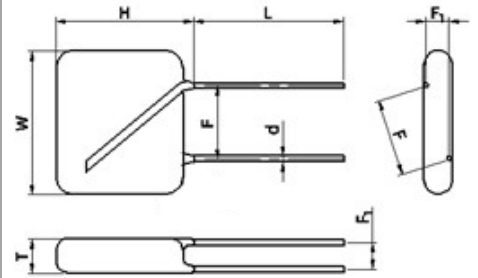
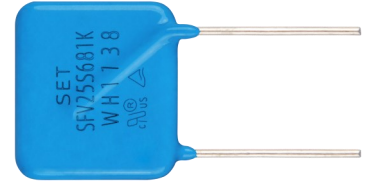

All Lead Wire A

**Note:**

The above data is for reference only.

### Part Numbering System

SFV 25 S 471 - K N K A BUL - 001

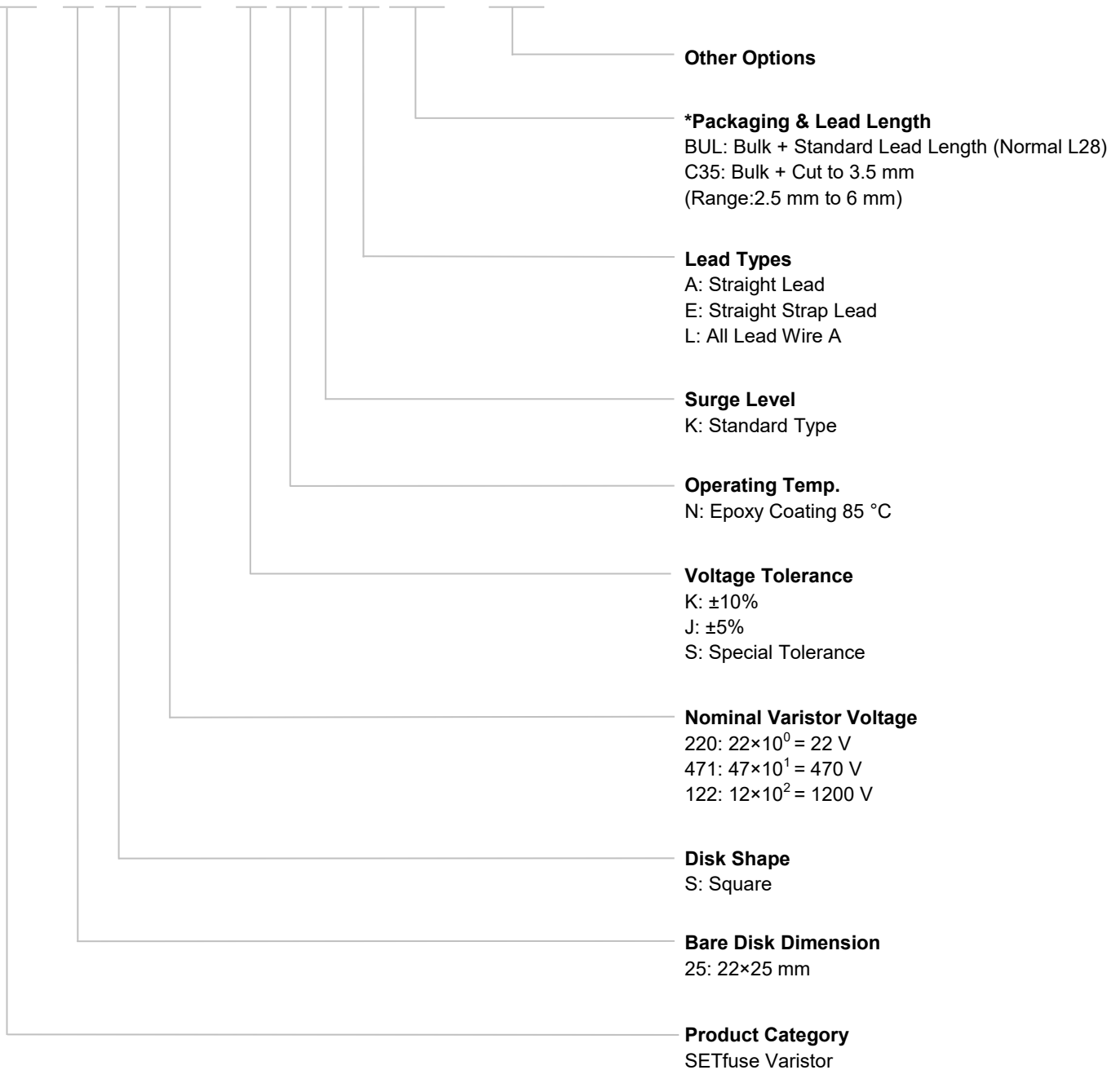

**Reminder:**

Part numbering system in the datasheet is only for selecting correct parameter and product features. Before placing order, please contact us for specifications and use the part number and product code in the specifications to place order to ensure the part is correct. Product code is the unique identification.

**Specification**

Model	Max. Continuous Operating Voltage		Varistor Voltage @1 mA DC		Clamping Voltage (Max.)		Max. Discharge Current (8/20 μs)		Max. Energy (10/1000 μs)	Typical Capacitance (For reference only) @1 kHz	Agency Information			
	VAC	VDC	Min.	Max.	V <sub>C</sub>	I <sub>P</sub>	I <sub>n</sub>	I <sub>max</sub>			(J)	(pF)	UL	cUL
	(V)	(V)	(V)	(V)	(V)	(A)	(kA)	(kA)	(J)	(pF)			UL	cUL
SFV25S220K	14	18	20	24	43	35	1.5	3	20	35000	●	●	○	○
SFV25S270K	17	22	24	31	53	35	3	6	33	30000	●	●	●	○
SFV25S330K	20	26	30	36	65	35	4	8	42	24500	●	●	●	○
SFV25S390K	25	31	35	43	77	35	4	8	49	21000	●	●	●	○
SFV25S470K	30	38	42	52	93	35	4	8	60	17250	●	●	●	○
SFV25S560K	35	45	50	62	110	35	5	10	72	14500	●	●	●	○
SFV25S680K	40	56	61	75	135	35	5	10	85	9500	●	●	●	○
SFV25S820K	50	65	74	90	135	175	10	25	98	8800	●	●	●	○
SFV25S101K	60	85	90	110	165	175	10	25	122	7200	●	●	●	○
SFV25S121K	75	100	108	132	200	175	10	25	146	6000	●	●	●	○
SFV25S151K	95	125	135	165	250	175	10	25	185	4400	●	●	●	○
SFV25S181K	115	150	162	198	300	175	10	25	218	3650	●	●	●	○
SFV25S201K	130	170	180	220	340	175	10	25	252	3300	●	●	●	○
SFV25S221K	140	180	198	242	360	175	10	25	280	3000	●	●	●	○
SFV25S241K	150	200	216	264	395	175	10	25	302	2800	●	●	●	○
SFV25S271K	175	225	243	297	455	175	10	25	340	2450	●	●	●	○
SFV25S301K	190	250	270	330	500	175	10	25	375	2200	●	●	●	○
SFV25S331K	210	275	297	363	550	175	10	25	410	2050	●	●	●	○
SFV25S361K	230	300	324	396	595	175	10	25	465	1850	●	●	●	○
SFV25S391K	250	320	351	429	650	175	10	25	520	1700	●	●	●	○
SFV25S431K	275	350	387	473	710	175	10	25	575	1600	●	●	●	○
SFV25S471K	300	385	423	517	775	175	10	25	630	1450	●	●	●	○
SFV25S511K	320	415	459	561	845	175	10	25	665	1300	●	●	●	○
SFV25S561K	350	460	504	616	925	175	10	25	720	1200	●	●	●	○
SFV25S621K	385	505	558	682	1025	175	10	25	790	1100	●	●	●	○
SFV25S681K	420	560	612	748	1120	175	10	25	790	1000	●	●	●	○
SFV25S751K	460	615	675	825	1240	175	10	25	825	900	●	●	●	○
SFV25S821K	510	670	738	902	1355	175	10	25	840	800	●	●	●	○
SFV25S911K	550	745	819	1001	1500	175	10	25	900	700	●	●	●	○
SFV25S102K	625	825	900	1100	1650	175	10	25	950	660	●	●	●	○
SFV25S112K	680	895	990	1210	1815	175	10	25	1040	615	●	●	●	○
SFV25S122K	750	1000	1080	1320	1980	175	10	25	1170	555	●	●	●	○

● : Approved      ○ : Unauthorized      ● : RoHS & REACH Compliant

**Performance Curve (For reference only )**

- Max. Peak Current Derating Curves

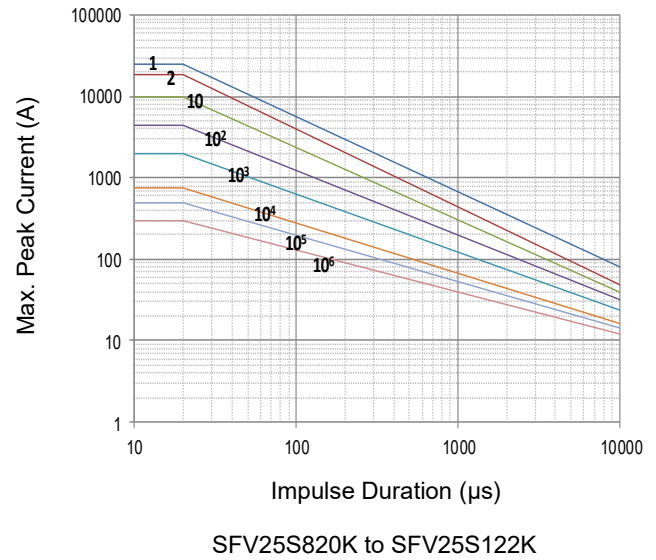
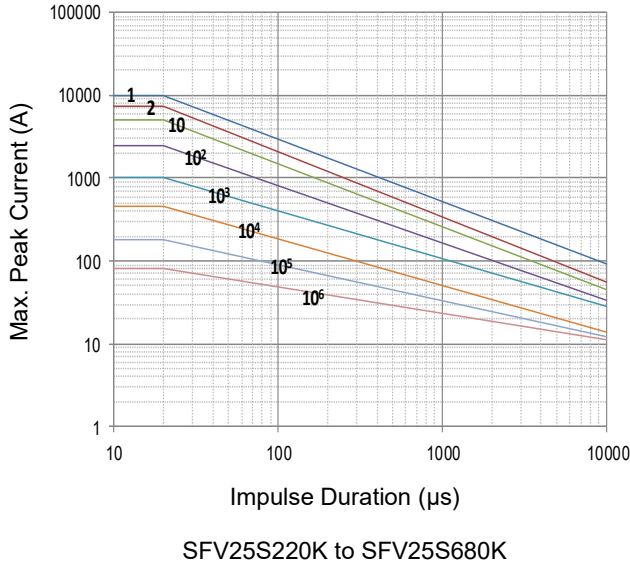

Note: 1, 2, 10, 10<sup>2</sup>, 10<sup>3</sup>, 10<sup>4</sup>, 10<sup>5</sup>, 10<sup>6</sup> Stand for Repetitions.

- Voltage-Current Characteristic Curves

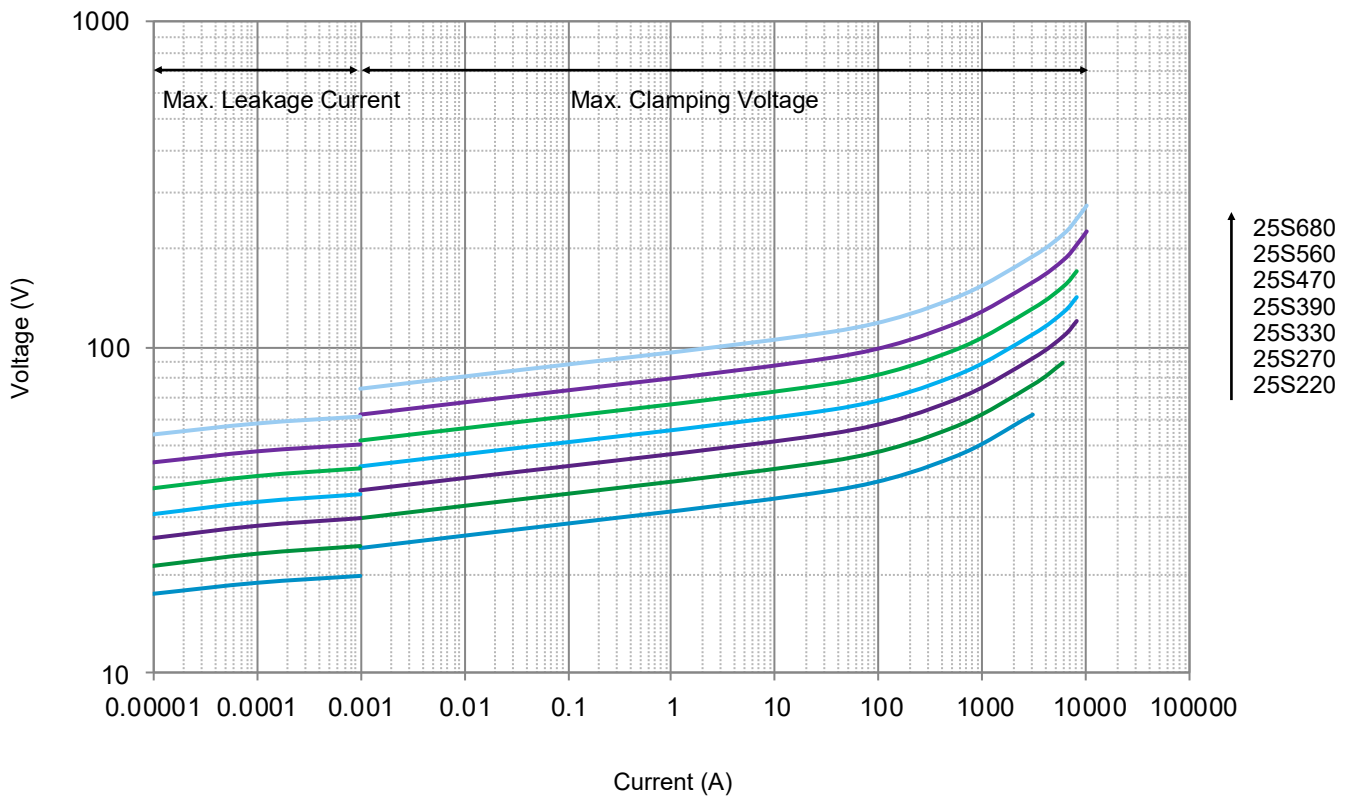



• Voltage-Current Characteristic Curves

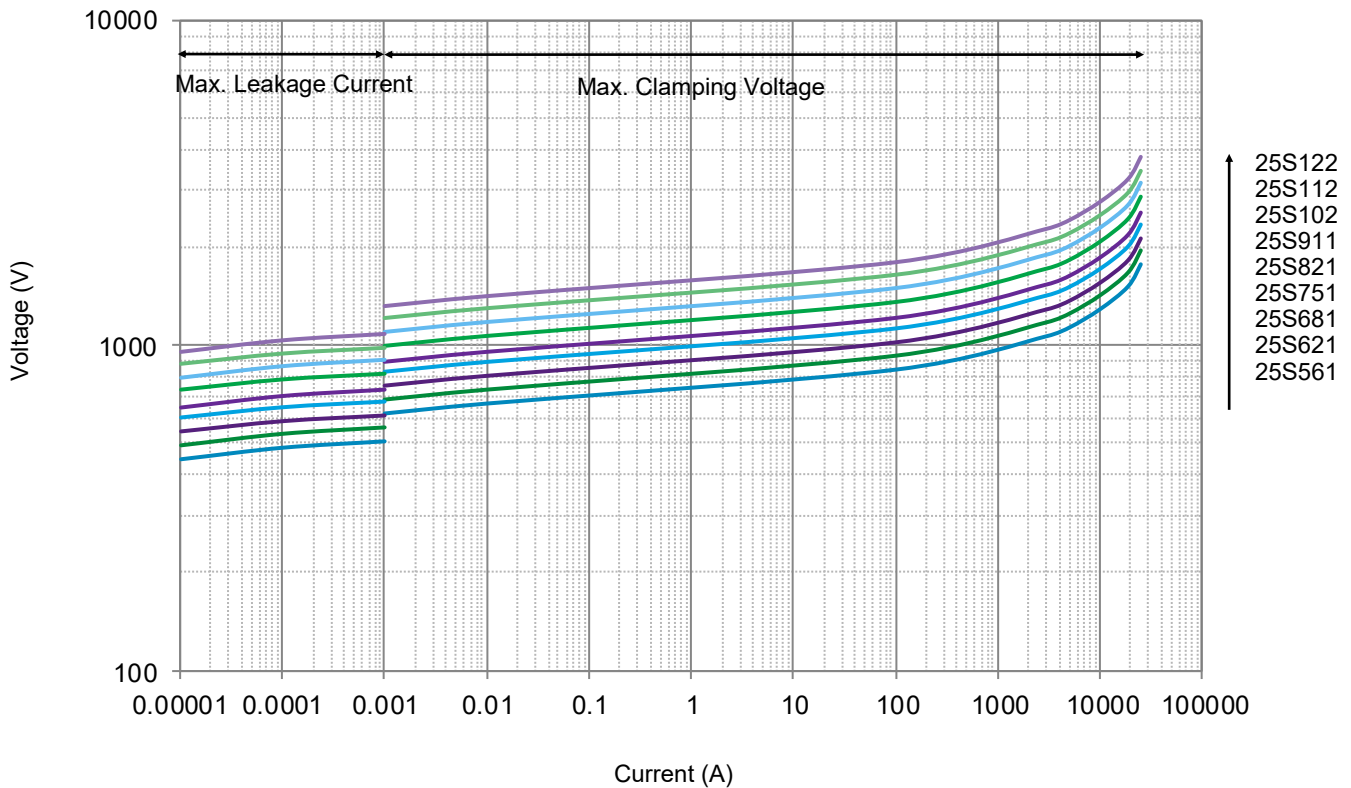
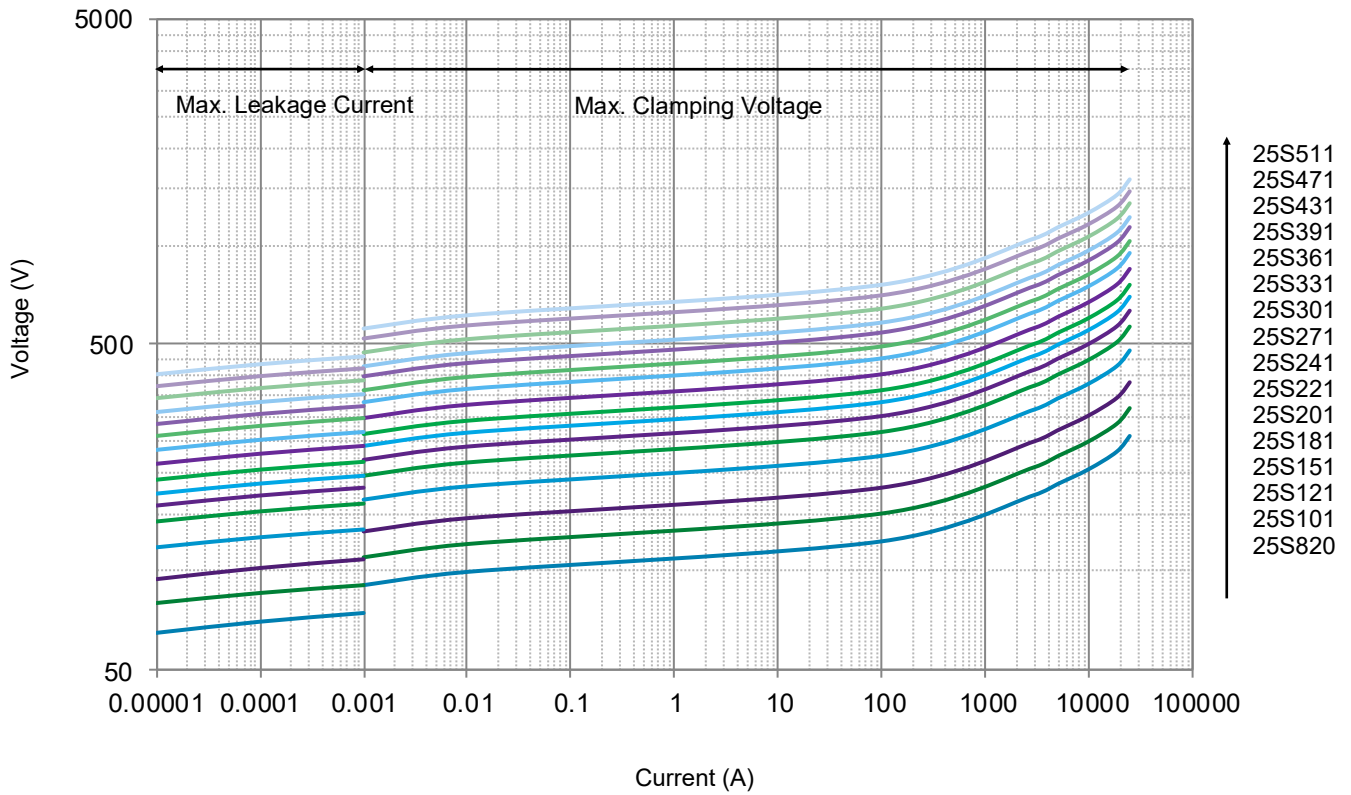

### Packaging Information

- Bulk Packaging (Code: BUL)
- Bulk Packaging Quantity & Weight.

Series	Nominal Varistor Voltage	PE Bag	Box	Carton	G. W / Carton (365 × 265 × 245)
	(V)	(PCS)	(PCS)	(PCS)	(kg)±10%
SFV25S Series	220 ~ 821	100	200	1200	10 ~ 26
	911 ~ 122	80	160	960	23 ~ 28

Note:  
Other lead length packaging information, please contact SETsafe | SETfuse.

All Dimensions in mm

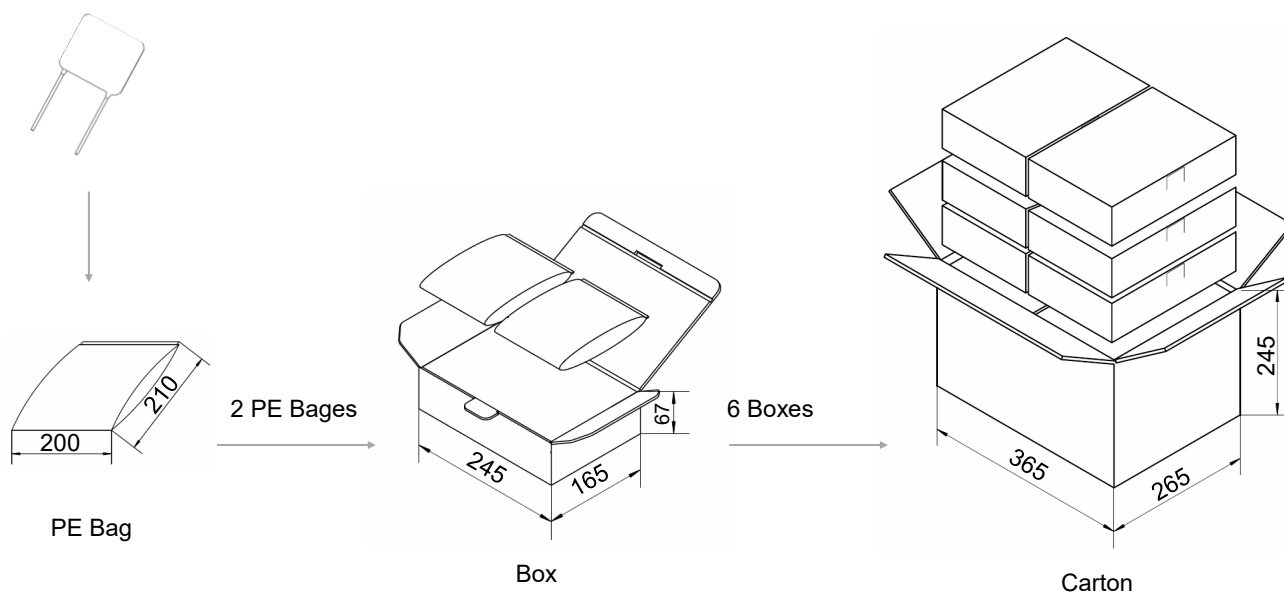

## Installation

### Mechanical Stress

Do not knock MOV when installing, to avoid mechanical damage.

## Soldering Parameters

### Wave Soldering Parameters

The wave soldering parameters are for reference only. When MOV is for practice use, some related validation is recommended.

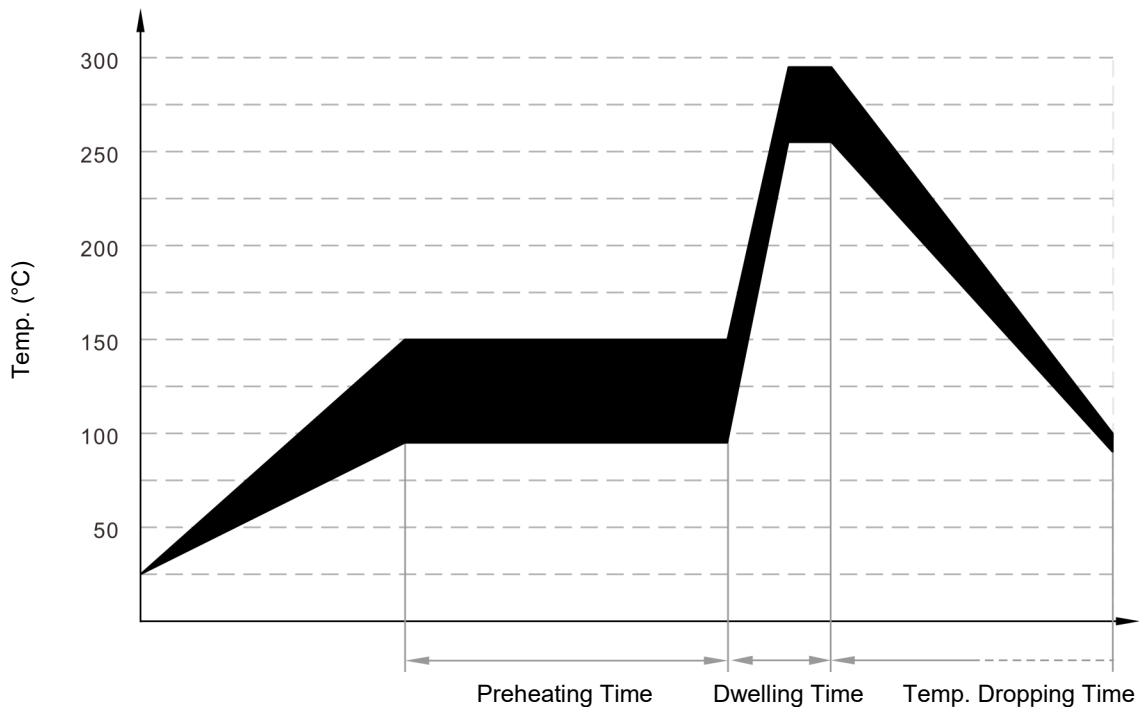

Wave Soldering Curve

Item	Temp. (°C)	Time (s)
Preheating	90 to 150	<150
Dwelling	255 to 290	3 to 10

## Recommended Hand-Soldering Parameters

Item	Condition
Temp. of Solder Head	350 °C (max.)
Soldering Time	4 seconds (max.)

## Glossary

Item	Description
$V_N$	<b>Nominal Varistor Voltage</b> Voltage, at specified D.C. current used as a reference point in the component characteristics. — (GB 18802.331) — (IEC 61051-1)
$I_L$	<b>Leakage Current</b> Measuring at 75% of varistor voltage. — (GB/T 10193) — (IEC 61051-1)
UCT	<b>Upper Category Temp.</b> Max. ambient temp. for which a varistor has been designed to operate continuously. — (GB/T 10193) — (IEC 61051-1)
LCT	<b>Lower Category Temp.</b> Minimum ambient temp. at which a varistor has been designed to operate continuously. — (GB/T 10193) — (IEC 61051-1)
Max. Peak Current	<b>Max. Peak Current</b> Max. current per pulse, which may be passed by a varistor at an ambient temp. of 25 °C, for a given number of pulses. — (GB/T 10193) — (IEC 61051-1)
$V_C$	<b>Clamping Voltage</b> Peak voltage developed across the varistor terminations under standard atmospheric conditions, when passing an 8/20 $\mu$ s class current pulse. — (GB 18802.331) — (IEC 61051-1)
Voltage Proof	<b>Voltage Proof</b> Max. peak voltage, which may be applied under continuous operating conditions between the varistor terminations and any conducting mounting surface (Applicable only to insulated varistors). — (GB/T 10193) — (IEC 61051-1)
$C_V$	<b>Capacitance</b> Capacitance across the MOV measured at a specified frequency and voltage. — (GB 18802.331) — (IEC 61051-1)
$V_{ac}$	<b>Max. Continuous a.c. Voltage</b> Max. a.c. r.m.s. voltage of a substantially sinusoidal waveform (less than 5% total harmonic distortion) which can be applied to the component under continuous operating conditions at 25 °C. — (GB/T 10193) — (IEC 61051-1)
$V_{dc}$	<b>Max. Continuous d.c. Voltage</b> Max. d.c. voltage (with less than 5% ripple) which can be applied to the component under continuous operating conditions at an ambient temp. of 25 °C. — (GB/T 10193) — (IEC 61051-1)
$I_{max}$	<b>Max. Discharge Current</b> Crest value of a current through the SPD having an 8/20 $\mu$ s waveshape and magnitude according to the manufacturers specification. $I_{max}$ is equal to or greater than $I_n$ . — (GB 18802.1) — (IEC 61643-11)



# ATTENTION

## Usage

1. Varistor must operated in the specified ambient temp.
2. Do not clean the varistor with strong polar solvent such as ketone, esters, benzene and halogenated hydrocarbon.
3. Please do not apply severe vibration, shock or pressure to MOV.
4. Please fix lead wires when bending or cutting. The distance between the bending point and the sealing of MOV shall be greater than 2 mm.

## Replacement

If varistor is visually damaged, please replace it.

## Storage

1. Storage Temp. Range: (-40 to +125) °C.
2. Relative Humidity : ≤75% RH.
3. Altitude: <2000 m.
4. Do not store the MOV at the high temp., high humidity or corrosive gas environment, to avoid influencing the solder-ability of the lead wires, the product shall be used up within 1 year after receiving the goods.

## Environmental Conditions

1. Varistor should neither be exposed to the open air, nor direct sunshine.
2. Varistor should avoid rain, water vapor or other condition of high temp. and high humidity.
3. Varistor should avoid sand dust, salt spray, or other harmful gases.

## Max. Typical Capacitance of Varistor

The typical capacitance of varistor is listed in the specifications. Designers may refer to it when designing MOV in high frequency circuit.

### Metal Oxide Varistor (MOV) Feature & Model List Overview

Nominal Operating Voltage $U_n$ (V)												Page		Model	Maximum Continuous Operating Voltage $U_n$ (V)
		0.5	1	1.75	2	3	3.5	6	10	20	70	AC	DC		
480V	500V							SFV10D122K(T)	SFV14D122K(T)	SFV20D122K(T)	SFV25D122K(T)	SFV53D122K	750	990	Maximum Continuous Operating Voltage $U_n$ (V)
								SFV10D112K(T)	SFV14D112K(T)	SFV20D112K(T)	SFV25D112K(T)	SFV53D112K	680	895	
415V							SFV10D102K(T)	SFV14D102K(T)	SFV20D102K(T)	SFV25D102K(T)	SFV53D102K	625	825		
380V							SFV10D911K(T)	SFV14D911K(T)	SFV20D911K(T)	SFV25D911K(T)	SFV53D911K	550	745		
				SFV7D821K(T)			SFV10D821K(T)	SFV14D821K(T)	SFV20D821K(T)	SFV25D821K(T)	SFV53D821K	510	670		
100V	250V						SFV10D751K(T)	SFV14D751K(T)	SFV20D751K(T)	SFV25D751K(T)	SFV53D751K	460	615		
							SFV10D681K(T)	SFV14D681K(T)	SFV20D681K(T)	SFV25D681K(T)	SFV53D681K	420	560		
240V							SFV10D621K(T)	SFV14D621K(T)	SFV20D621K(T)	SFV25D621K(T)	SFV53D621K	385	505		
							SFV10D561K(T)	SFV14D561K(T)	SFV20D561K(T)	SFV25D561K(T)	SFV53D561K	350	460		
100V	125V						SFV10D511K(T)	SFV14D511K(T)	SFV20D511K(T)	SFV25D511K(T)	SFV53D511K	320	415		
							SFV10D471K(T)	SFV14D471K(T)	SFV20D471K(T)	SFV25D471K(T)	SFV53D471K	300	385		
220V							SFV10D431K(T)	SFV14D431K(T)	SFV20D431K(T)	SFV25D431K(T)	SFV53D431K	275	350		
							SFV10D391K(T)	SFV14D391K(T)	SFV20D391K(T)	SFV25D391K(T)	SFV53D391K	250	320		
100V	120V						SFV10D361K(T)	SFV14D361K(T)	SFV20D361K(T)	SFV25D361K(T)	SFV53D361K	230	300		
							SFV10D331K(T)	SFV14D331K(T)	SFV20D331K(T)	SFV25D331K(T)	SFV53D331K	210	275		
100V	100V						SFV10D301K(T)	SFV14D301K(T)	SFV20D301K(T)	SFV25D301K(T)	SFV53D301K	190	250		
							SFV10D271K(T)	SFV14D271K(T)	SFV20D271K(T)	SFV25D271K(T)	SFV53D271K	175	225		
48V	24V						SFV10D241K(T)	SFV14D241K(T)	SFV20D241K(T)	SFV25D241K(T)	SFV53D241K	150	200		
							SFV10D221K(T)	SFV14D221K(T)	SFV20D221K(T)	SFV25D221K(T)	SFV53D221K	140	180		
24V	12V						SFV10D201K(T)	SFV14D201K(T)	SFV20D201K(T)	SFV25D201K(T)	SFV53D201K	130	170		
							SFV10D181K(T)	SFV14D181K(T)	SFV20D181K(T)	SFV25D181K(T)	SFV53D181K	115	150		
12V	12V						SFV10D151K(T)	SFV14D151K(T)	SFV20D151K(T)	SFV25D151K(T)	SFV53D151K	95	125		
							SFV10D121K(T)	SFV14D121K(T)	SFV20D121K(T)	SFV25D121K(T)	SFV53D121K	75	100		
12V	12V						SFV10D101K(T)	SFV14D101K(T)	SFV20D101K(T)	SFV25D101K(T)	SFV53D101K	60	85		
							SFV10D820K(T)	SFV14D820K(T)	SFV20D820K(T)	SFV25D820K(T)	SFV53D820K	50	65		
AC	DC						SFV7D680K(T)	SFV10D680K(T)	SFV14D680K(T)	SFV20D680K(T)	SFV25D680K(T)			40	56
							SFV7D560K(T)	SFV10D560K(T)	SFV14D560K(T)	SFV20D560K(T)	SFV25D560K(T)			35	45
AC	DC						SFV7D470K(T)	SFV10D470K(T)	SFV14D470K(T)	SFV20D470K(T)	SFV25D470K(T)			30	38
							SFV7D390K(T)	SFV10D390K(T)	SFV14D390K(T)	SFV20D390K(T)	SFV25D390K(T)			25	31
AC	DC						SFV7D330K(T)	SFV10D330K(T)	SFV14D330K(T)	SFV20D330K(T)	SFV25D330K(T)			20	26
							SFV7D270K(T)	SFV10D270K(T)	SFV14D270K(T)	SFV20D270K(T)	SFV25D270K(T)			17	22
AC	DC						SFV7D220K(T)	SFV10D220K(T)	SFV14D220K(T)	SFV20D220K(T)	SFV25D220K(T)			14	18

**Metal Oxide Varistor (MOV) Feature & Model List Overview**

Nominal Operating Voltage $U_n$ (V)						Page		Model
						AC	DC	
480V	500V	○	SFV10D122KM	SFV14D122KM	SFV20D122KM	SFV25D122KM	750	990
		○	SFV10D112KM	SFV14D112KM	SFV20D112KM	SFV25D112KM	680	895
		○	SFV10D102KM	SFV14D102KM	SFV20D102KM	SFV25D102KM	625	825
		○	SFV10D911KM	SFV14D911KM	SFV20D911KM	SFV25D911KM	550	745
415V	500V	SFV7D821KM	SFV10D821KM	SFV14D821KM	SFV20D821KM	SFV25D821KM	510	670
		SFV7D751KM	SFV10D751KM	SFV14D751KM	SFV20D751KM	SFV25D751KM	460	615
380V	500V	SFV7D681KM	SFV10D681KM	SFV14D681KM	SFV20D681KM	SFV25D681KM	420	560
		SFV7D621KM	SFV10D621KM	SFV14D621KM	SFV20D621KM	SFV25D621KM	385	505
100V	240V	SFV7D561KM	SFV10D561KM	SFV14D561KM	SFV20D561KM	SFV25D561KM	350	460
		SFV7D511KM	SFV10D511KM	SFV14D511KM	SFV20D511KM	SFV25D511KM	320	415
100V	240V	SFV7D471KM	SFV10D471KM	SFV14D471KM	SFV20D471KM	SFV25D471KM	300	385
		SFV7D431KM	SFV10D431KM	SFV14D431KM	SFV20D431KM	SFV25D431KM	275	350
100V	250V	SFV7D391KM	SFV10D391KM	SFV14D391KM	SFV20D391KM	SFV25D391KM	250	320
		SFV7D361KM	SFV10D361KM	SFV14D361KM	SFV20D361KM	SFV25D361KM	230	300
120V	250V	SFV7D331KM	SFV10D331KM	SFV14D331KM	SFV20D331KM	SFV25D331KM	210	275
		SFV7D301KM	SFV10D301KM	SFV14D301KM	SFV20D301KM	SFV25D301KM	190	250
100V	125V	SFV7D271KM	SFV10D271KM	SFV14D271KM	SFV20D271KM	SFV25D271KM	175	225
		SFV7D241KM	SFV10D241KM	SFV14D241KM	SFV20D241KM	SFV25D241KM	150	200
100V	125V	SFV7D221KM	SFV10D221KM	SFV14D221KM	SFV20D221KM	SFV25D221KM	140	180
		SFV7D201KM	SFV10D201KM	SFV14D201KM	SFV20D201KM	SFV25D201KM	130	170
48V	125V	SFV7D181KM	SFV10D181KM	SFV14D181KM	SFV20D181KM	SFV25D181KM	115	150
		SFV7D151KM	SFV10D151KM	SFV14D151KM	SFV20D151KM	SFV25D151KM	95	125
48V	125V	SFV7D121KM	SFV10D121KM	SFV14D121KM	SFV20D121KM	SFV25D121KM	75	100
		SFV7D101KM	SFV10D101KM	SFV14D101KM	SFV20D101KM	SFV25D101KM	60	85
24V	12V	SFV7D820KM	SFV10D820KM	SFV14D820KM	SFV20D820KM	SFV25D820KM	50	65
		○	○	SFV25D680KM	○	○	40	56
24V	12V	○	○	SFV25D560KM	○	○	35	45
		○	○	SFV25D470KM	○	○	30	38
12V	12V	○	○	○	○	○	25	31
		○	○	○	○	○	20	26
AC	DC	○	○	○	○	○	17	22
		○	○	○	○	○	14	18

Maximum Peak Current (8/20  $\mu$ s) (kA)

**Metal Oxide Varistor (MOV) Feature & Model List Overview**

Nominal Operating Voltage $U_n$ (V)		Model											Page	
		2	3	5	6	8	10	15	20	25	40	AC	DC	
480V	500V	○	○	○	○	○	○	SFV20S122K	○	SFV25S122K	SFV34S122K	750	990	
		○	○	○	○	○	○	SFV20S112K	○	SFV25S112K	SFV34S112K	680	895	
415V	500V	○	○	○	○	○	○	SFV20S102K	○	SFV25S102K	SFV34S102K	625	825	
		○	○	○	○	○	○	SFV20S911K	○	SFV25S911K	SFV34S911K	550	745	
380V	500V	○	○	SFV10S821K	○	○	○	SFV15S821K	○	SFV25S821K	SFV34S821K	510	670	
		○	○	SFV10S751K	○	○	○	SFV15S751K	○	SFV25S751K	SFV34S751K	460	615	
100V	240V	○	○	SFV10S681K	○	○	○	SFV15S681K	SFV20S681K	○	SFV25S681K	SFV34S681K	420	560
		○	○	SFV10S621K	○	○	○	SFV15S621K	SFV20S621K	○	SFV25S621K	SFV34S621K	385	505
100V	240V	○	○	SFV10S561K	○	○	○	SFV15S561K	SFV20S561K	○	SFV25S561K	SFV34S561K	350	460
		○	○	SFV10S511K	○	○	○	SFV15S511K	SFV20S511K	○	SFV25S511K	SFV34S511K	320	415
100V	220V	○	○	SFV10S471K	○	○	○	SFV15S471K	SFV20S471K	○	SFV25S471K	SFV34S471K	300	385
		○	○	SFV10S431K	○	○	○	SFV15S431K	SFV20S431K	○	SFV25S431K	SFV34S431K	275	350
100V	250V	○	○	SFV10S391K	○	○	○	SFV15S391K	SFV20S391K	○	SFV25S391K	SFV34S391K	250	320
		○	○	SFV10S361K	○	○	○	SFV15S361K	SFV20S361K	○	SFV25S361K	SFV34S361K	230	300
120V	250V	○	○	SFV10S331K	○	○	○	SFV15S331K	SFV20S331K	○	SFV25S331K	SFV34S331K	210	275
		○	○	SFV10S301K	○	○	○	SFV15S301K	SFV20S301K	○	SFV25S301K	SFV34S301K	190	250
125V	100V	○	○	SFV10S271K	○	○	○	SFV15S271K	SFV20S271K	○	SFV25S271K	SFV34S271K	175	225
		○	○	SFV10S241K	○	○	○	SFV15S241K	SFV20S241K	○	SFV25S241K	SFV34S241K	150	200
100V	100V	○	○	SFV10S221K	○	○	○	SFV15S221K	SFV20S221K	○	SFV25S221K	SFV34S221K	140	180
		○	○	SFV10S201K	○	○	○	SFV15S201K	SFV20S201K	○	SFV25S201K	SFV34S201K	130	170
48V	24V	○	○	SFV10S181K	○	○	○	SFV15S181K	SFV20S181K	○	SFV25S181K	SFV34S181K	115	150
		○	○	SFV10S151K	○	○	○	SFV15S151K	SFV20S151K	○	SFV25S151K	SFV34S151K	95	125
24V	24V	○	SFV10S121K	○	○	○	○	SFV15S121K	SFV20S121K	○	SFV25S121K	SFV34S121K	75	100
		○	SFV10S101K	○	○	○	○	SFV15S101K	SFV20S101K	○	SFV25S101K	SFV34S101K	60	85
12V	12V	○	SFV10S820K	○	○	○	○	SFV15S820K	SFV20S820K	○	SFV25S820K	SFV34S820K	50	65
		SFV10S680K	SFV15S680K	SFV20S680K	○	○	○	SFV25S680K	○	SFV34S680K	○	○	40	56
12V	12V	SFV10S560K	SFV15S560K	SFV20S560K	○	○	SFV25S560K	○	SFV34S560K	○	○	35	45	
		SFV10S470K	SFV15S470K	SFV20S470K	○	○	SFV25S470K	○	SFV34S470K	○	○	30	38	
12V	12V	SFV10S390K	SFV15S390K SFV20S390K	○	○	○	SFV25S390K	○	○	○	○	25	31	
		SFV10S330K	SFV15S330K SFV20S330K	○	○	○	SFV25S330K	○	○	○	○	20	26	
12V	12V	SFV10S270K	SFV15S270K SFV20S270K	○	○	SFV25S270K	○	○	○	○	○	17	22	
		SFV10S220K	SFV15S220K SFV20S220K SFV25S220K	○	○	○	○	○	○	○	○	14	18	